



Micro Commercial Components



Micro Commercial Components
 20736 Marilla Street Chatsworth
 CA 91311
 Phone: (818) 701-4933
 Fax: (818) 701-4939

SI2303

P-Channel Enhancement Mode Field Effect Transistor

Features

- 30V, -2.6A, $R_{DS(ON)}=130m\Omega$ @ $V_{GS}=-10V$
- 30V, -2.0A, $R_{DS(ON)}=180m\Omega$ @ $V_{GS}=-4.5V$
- High dense cell design for extremely low $R_{DS(ON)}$
- Rugged and reliable
- Lead free product is acquired
- SOT-23 Package
- Marking Code: S3
- Epoxy meets UL 94 V-0 flammability rating
- Moisture Sensitivity Level 1

Maximum Ratings @ 25°C Unless Otherwise Specified

Symbol	Parameter	Rating	Unit
V_{DS}	Drain-source Voltage	-30	V
I_D	Drain Current-Continuous	-3	A
I_{DM}	Drain Current-Pulsed ^a	-10	A
V_{GS}	Gate-source Voltage	± 20	V
P_D	Total Power Dissipation	0.25	W
$R_{\theta JA}$	Thermal Resistance Junction to Ambient ^b	500	$^{\circ}C/W$
T_J	Operating Junction Temperature	-55 to +150	$^{\circ}C$
T_{STG}	Storage Temperature	-55 to +150	$^{\circ}C$

SOT-23

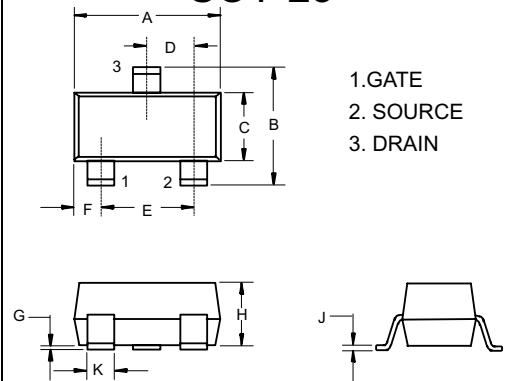

DIM	INCHES		MM		NOTE
	MIN	MAX	MIN	MAX	
A	.110	.120	2.80	3.04	
B	.083	.098	2.10	2.64	
C	.047	.055	1.20	1.40	
D	.035	.041	.89	1.03	
E	.070	.081	1.78	2.05	
F	.018	.024	.45	.60	
G	.0005	.0039	.013	.100	
H	.035	.044	.89	1.12	
J	.003	.007	.085	.180	
K	.015	.020	.37	.51	

Internal Block Diagram

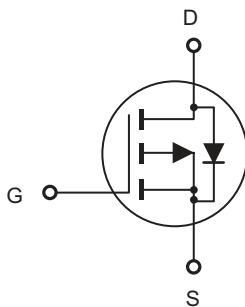

Suggested Solder Pad Layout

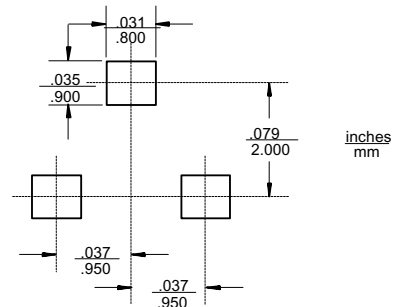



Electrical Characteristics $T_A = 25^\circ\text{C}$ unless otherwise noted

Parameter	Symbol	Test Condition	Min	Typ	Max	Units
Off Characteristics						
Drain-Source Breakdown Voltage	BV_{DSS}	$V_{GS} = 0V, I_D = -10\mu A$	-30			V
Zero Gate Voltage Drain Current	I_{DSS}	$V_{DS} = -30V, V_{GS} = 0V$			-1	μA
Gate Body Leakage Current, Forward	I_{GSSF}	$V_{GS} = 20V, V_{DS} = 0V$			100	nA
Gate Body Leakage Current, Reverse	I_{GSSR}	$V_{GS} = -20V, V_{DS} = 0V$			-100	nA
On Characteristics^c						
Gate Threshold Voltage	$V_{GS(th)}$	$V_{GS} = V_{DS}, I_D = -250\mu A$	-1		-3	V
Static Drain-Source On-Resistance	$R_{DS(on)}$	$V_{GS} = -10V, I_D = -2.6A$			130	m Ω
		$V_{GS} = -4.5V, I_D = -2.0A$			180	m Ω
Forward Transconductance	g_{FS}	$V_{DS} = -10V, I_D = -1.7A$		2.4		S
Dynamic Characteristics^d						
Input Capacitance	C_{iss}	$V_{DS} = -15V, V_{GS} = 0V,$ $f = 1.0\text{ MHz}$		226		pF
Output Capacitance	C_{oss}			87		pF
Reverse Transfer Capacitance	C_{rss}			19		pF
Switching Characteristics^d						
Turn-On Delay Time	$t_{d(on)}$	$V_{DD} = -15V, I_D = -1A,$ $V_{GEN} = -10V, R_G = 6\Omega,$ $R_L = 15\Omega$		9	20	ns
Turn-On Rise Time	t_r			9	20	ns
Turn-Off Delay Time	$t_{d(off)}$			18	35	ns
Turn-Off Fall Time	t_f			6	20	ns
Total Gate Charge	Q_g	$V_{DS} = -15V, I_D = -1.7A,$ $V_{GS} = -10V$		5.8	10	nC
Gate-Source Charge	Q_{gs}			0.8		nC
Gate-Drain Charge	Q_{gd}			1.5		nC
Drain-Source Diode Characteristics and Maximum Ratings						
Drain-Source Diode Forward Voltage ^c	V_{SD}	$V_{GS} = 0V, I_S = -1.25A$			-1.2	V

Notes :
a.Repetitive Rating : Pulse width limited by maximum junction temperature.
b.Surface Mounted on FR4 Board, $t < 10\text{ sec}$.
c.Pulse Test : Pulse Width $< 300\mu s$, Duty Cycle $< 2\%$.
d.Guaranteed by design, not subject to production testing.

Typical characteristics

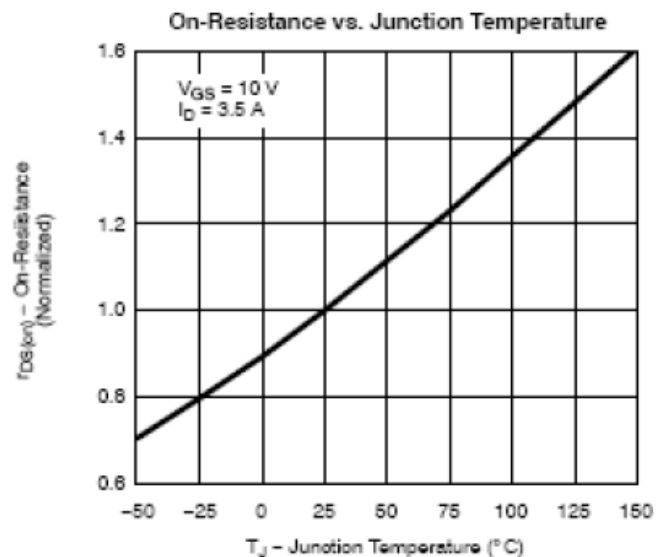
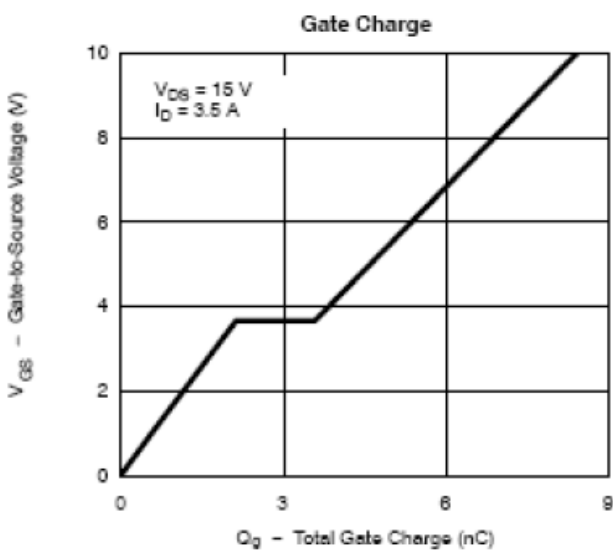
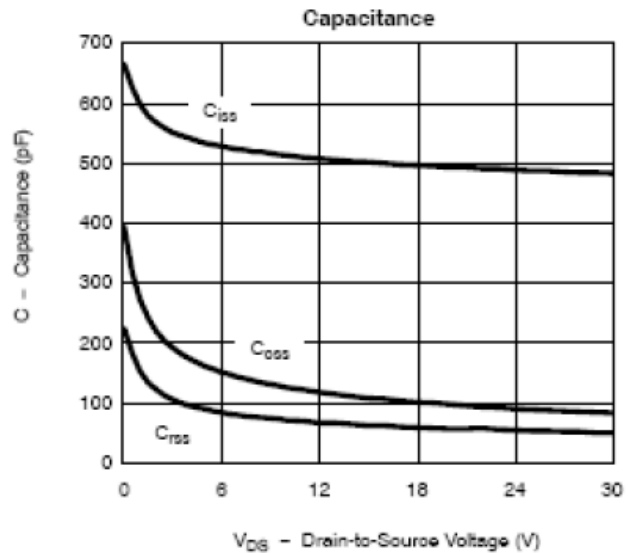
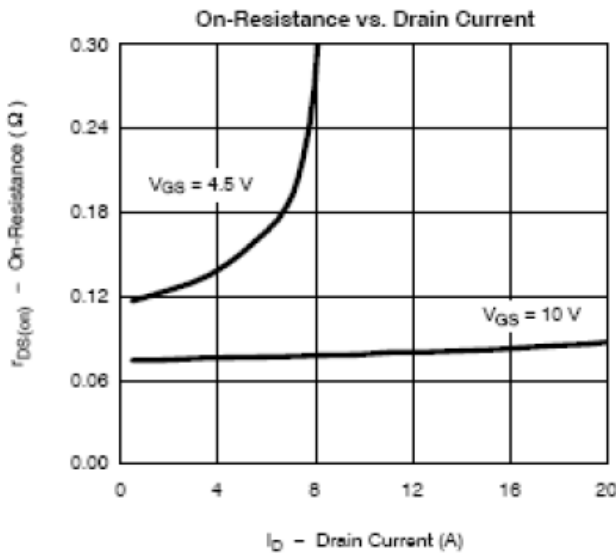
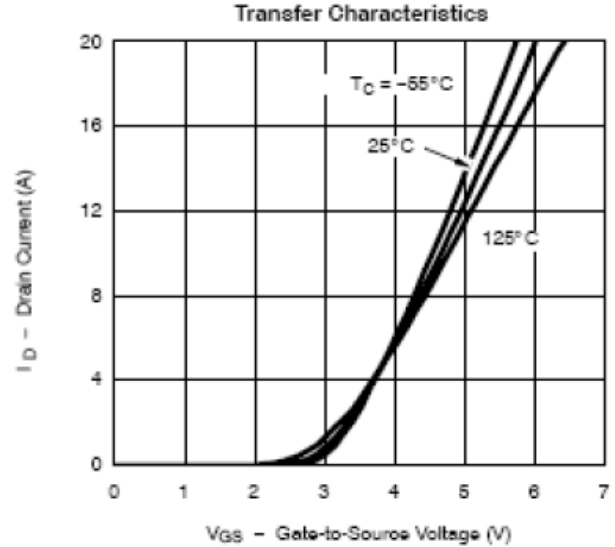
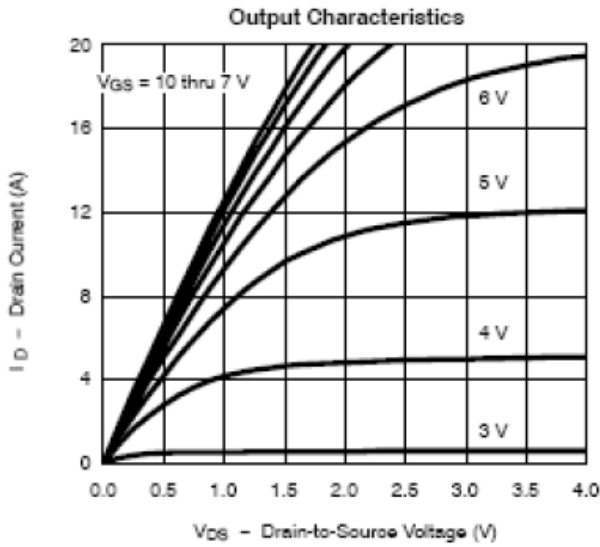

Typical characteristics

Source-Drain Diode Forward Voltage

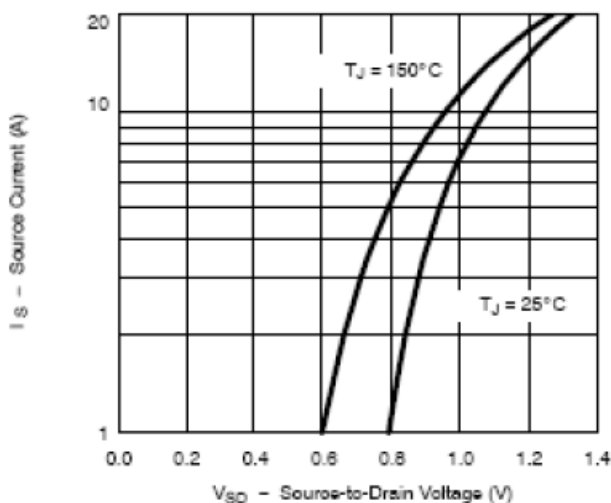

On-Resistance vs. Gate-to-Source Voltage

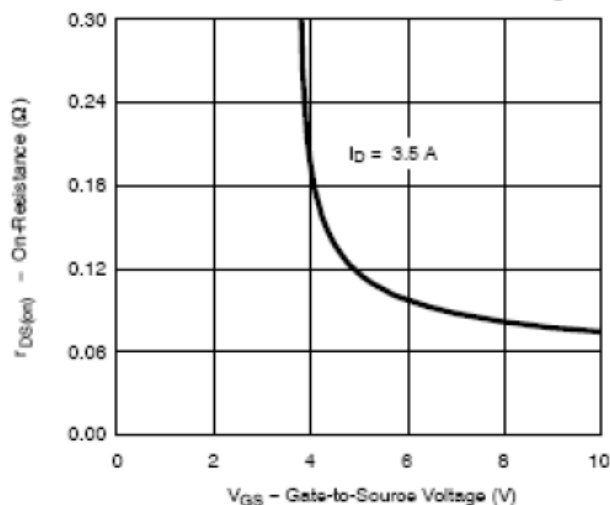

Threshold Voltage

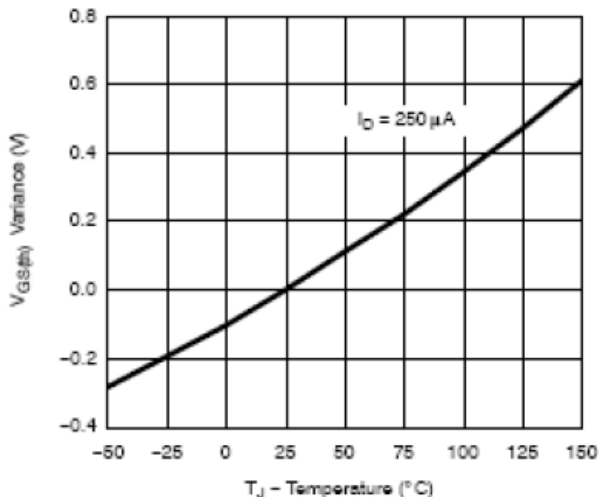

Single Pulse Power

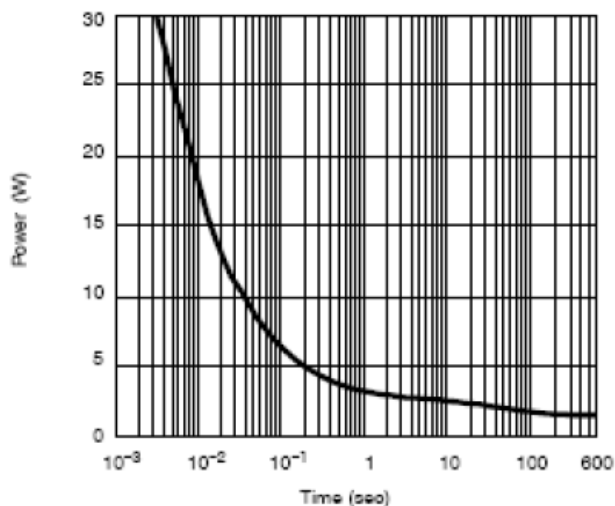

Normalized Thermal Transient Impedance, Junction-to-Ambient

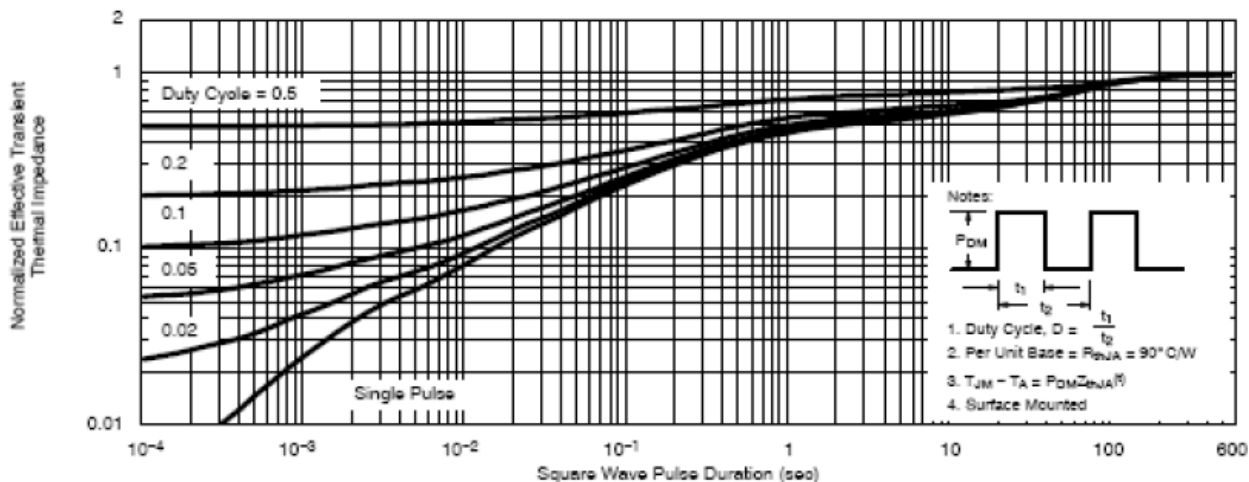



Micro Commercial Components

Ordering Information :

Device	Packing
Part Number-TP	Tape&Reel: 3Kpcs/Reel

*****IMPORTANT NOTICE*****

Micro Commercial Components Corp. reserves the right to make changes without further notice to any product herein to make corrections, modifications , enhancements , improvements , or other changes . **Micro Commercial Components Corp .** does not assume any liability arising out of the application or use of any product described herein; neither does it convey any license under its patent rights ,nor the rights of others . The user of products in such applications shall assume all risks of such use and will agree to hold **Micro Commercial Components Corp .** and all the companies whose products are represented on our website, harmless against all damages.

*****LIFE SUPPORT*****

MCC's products are not authorized for use as critical components in life support devices or systems without the express written approval of Micro Commercial Components Corporation.

*****CUSTOMER AWARENESS*****

Counterfeiting of semiconductor parts is a growing problem in the industry. Micro Commercial Components (MCC) is taking strong measures to protect ourselves and our customers from the proliferation of counterfeit parts. MCC strongly encourages customers to purchase MCC parts either directly from MCC or from Authorized MCC Distributors who are listed by country on our web page cited below. Products customers buy either from MCC directly or from Authorized MCC Distributors are genuine parts, have full traceability, meet MCC's quality standards for handling and storage. **MCC will not provide any warranty coverage or other assistance for parts bought from Unauthorized Sources.** MCC is committed to combat this global problem and encourage our customers to do their part in stopping this practice by buying direct or from authorized distributors.